

Ball Valve Standard Port

Model # 60FBA-SWFR (WCB)

Model # 60FBA-SFFR (316SS)

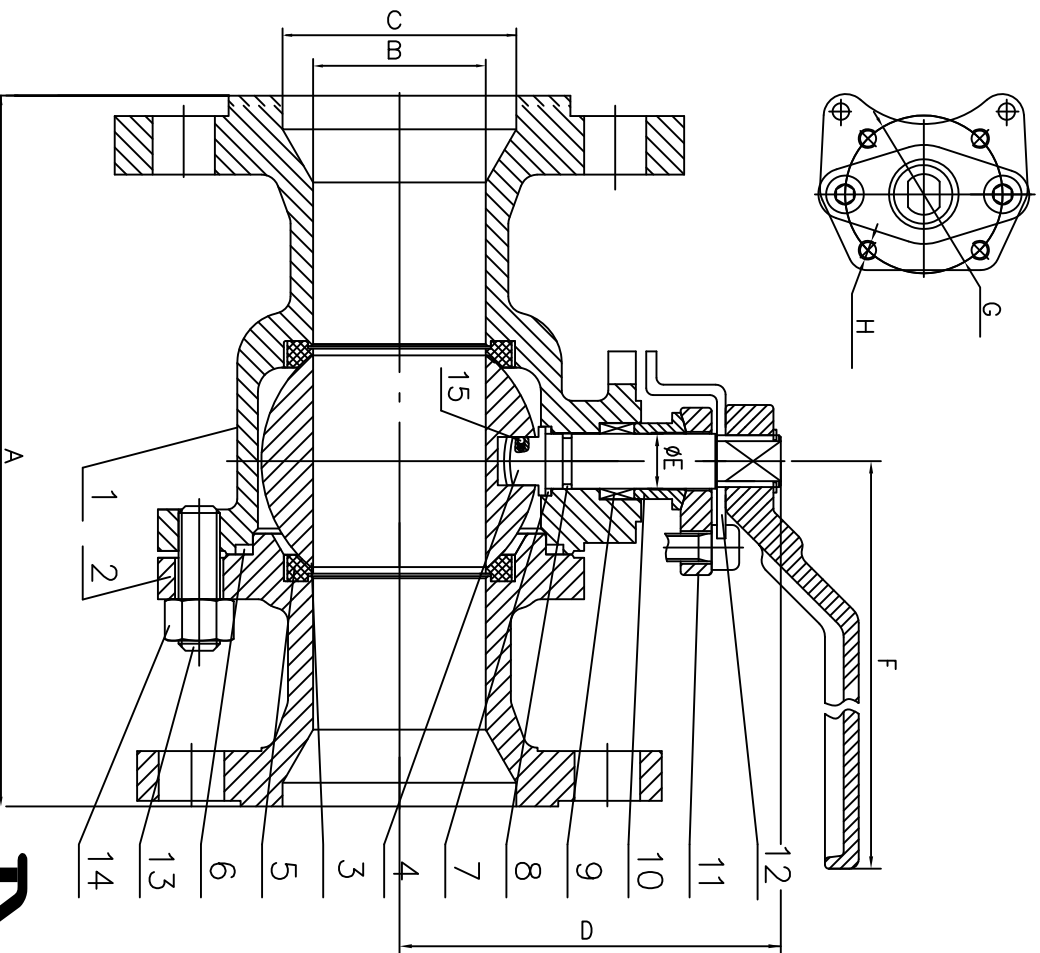

Designed to ASME B16.34/API 608
 Face to Face to ASME/ANSI B16.10
 Flange Dimensions to ASME/ANSI B16.5
 Tested to API 598
 API 607 Fire Safe
 ISO 5211 Mounting Pad

No.	Part	WCB	316SS
1	Body	WCB	CF8M
2	Bonnet	WCB	CF8M
3	Ball	316SS	316SS
4	Stem	316SS	316SS
5	Seat	RP TFE	RP TFE
6	Gasket	316+graphite	316+graphite
7	Gasket	PTFE	PTFE
8	O-Ring	VITON	VITON
9	Packing	Graphite	Graphite/PTFE
10	Packing Gland	A105	304SS
11	Gland	WCB	CF8
12	Stop	CS+Zn	304
13	Stud	A193 B7	A193 B8
14	Nut	A194 2H	A194 8
15	Anti-Static	SS	SS

Size in	A	B	C	D	E	F	G	H	Wt lbs
2	11.5	1.5	2.0	3.8	.63	7.5	2.0	4-M6	39
2-1/2	13.0	2.0	2.5	4.3	.79	11.0	2.75	4-M8	60
3	14.0	2.0	3.0	4.6	.94	11.0	2.75	4-M8	73
4	17.0	3.0	4.0	7.3	.94	14.2	2.75	4-M8	137
6	22.0	4.0	6.0	8.9	1.5	17.7	4.0	4-M10	223

